

Contribution from the Department of Inorganic and Physical Chemistry, Indian Institute of Science, Bangalore 560012, India, and Department of Chemistry, Birkbeck College (University of London), London WC1E 7HX, United Kingdom

Studies of Phosphazenes. 9.¹ Reactions of (Primary amino)chlorocyclotetraphosphazenes with Dimethylamine: Formation of "Bicyclic" Phosphazenes

S. S. KRISHNAMURTHY,*² K. RAMACHANDRAN,² ARJUN C. SAU,² ROBERT A. SHAW,³ A. R. VASUDEVA MURTHY,² and MICHAEL WOODS³

Received December 21, 1978

The reactions of hexachloro-2,6-bis(alkylamino)cyclotetraphosphazenes, $N_4P_4Cl_6(NHR)_2$ ($R = Me, Et, n\text{-Pr}, n\text{-Bu}, CH_2Ph$), and the mixed amino derivative $N_4P_4Cl_6(NH-t\text{-Bu})(NHEt)$ with an excess of dimethylamine in chloroform or methyl cyanide give the novel "bicyclic" phosphazenes $N_4P_4(NMe_2)_5(NHR)(NR)$ and $N_4P_4(NMe_2)_5(NH-t\text{-Bu})(NEt)$, respectively. The fully aminolyzed cyclotetraphosphazene derivatives $N_4P_4(NMe_2)_6(NHR)_2$ are also formed. In most cases, the yields of the two types of products have been estimated by ^{31}P NMR spectroscopy. "Bicyclic" phosphazenes are not formed when R is an α -branched group ($t\text{-Bu}, i\text{-Pr}, Ph$). The 1H and ^{31}P NMR and IR spectra of the "bicyclic" phosphazenes are discussed. A proton abstraction mechanism has been proposed for the trans-annular nucleophilic substitution reaction leading to the formation of "bicyclic" phosphazenes.

The reaction of hexachloro-2-*trans*-6-bis(ethylamino)-cyclotetraphosphazetetraene, $N_4P_4Cl_6(NHEt)_2$ (I), with an excess of dimethylamine in chloroform gives the cyclotetraphosphazene derivative $N_4P_4(NMe_2)_6(NHEt)_2$ (II), its dihydrochloride adduct $N_4P_4(NMe_2)_6(NHEt)_2 \cdot 2HCl$ (III), and the trans-annular-bridged "bicyclic" cyclotetraphosphazetetraene $N_4P_4(NMe_2)_5(NHEt)(NEt)$ (IV). An analogous reaction in diethyl ether yields only compound II^{4,5} (Figure 1). "Bicyclic" phosphazenes, $N_4P_4(NHR)_6(NR)$ ($R = Me, Et$), are also formed in the reactions of the octachloride, $N_4P_4Cl_8$, with methylamine and ethylamine in chloroform.^{1,4} In this paper, we describe the reactions of other hexachlorobis(amino)cyclotetraphosphazenes, $N_4P_4Cl_6(NHR)_2$ ($R = Me, n\text{-Pr}, i\text{-Pr}, n\text{-Bu}, t\text{-Bu}, CH_2Ph$, and Ph), with dimethylamine with a view to establishing the effect of the substituent (R) on the formation of "bicyclic" phosphazenes. We also report the reactions of compound I with dimethylamine in other organic solvents.

Experimental Section

The bis(alkylamino) derivatives $N_4P_4Cl_6(NHR)_2$ ($R = Me, Et, n\text{-Pr}, i\text{-Pr}, n\text{-Bu}, t\text{-Bu}, CH_2Ph$, and Ph) and the mixed amino derivative $N_4P_4Cl_6(NH-t\text{-Bu})(NHEt)$ were prepared by standard procedures.⁵⁻⁷ Dimethylamine, triethylamine, and organic solvents were purified by conventional methods.

Reaction of $N_4P_4Cl_6(NHMe)_2$ with an Excess of Dimethylamine in Chloroform. Dimethylamine (22.5 g, 500 mmol) was added to a stirred solution of $N_4P_4Cl_6(NHMe)_2$ (4.5 g, 10 mmol) in chloroform (200 cm³) at 0 °C. After 1 h, the temperature was raised slowly to ca. 58 °C and the reaction mixture was heated under reflux for 3 h (condenser cooled at ca. -70 °C). Dimethylamine hydrochloride was filtered off and evaporation of the solvent gave a viscous oil. The oil was digested with hot petroleum ether (bp 60-80 °C) and the extract was filtered to remove traces of dimethylamine hydrochloride. The filtrate was concentrated to ~20 cm³ and cooled to 0 °C. Three crude crops of crystals were obtained (72 h) which on recrystallization from 2,4,4,8,8-pentakis(dimethylamino)-6-(methylamino)-9-methyl-2,6-epiminocyclotetraphosphazetetraene, $N_4P_4(NMe_2)_5(NHMe)(NMe)$ (V), mp 116 °C (1.4 g, 30%). Anal. Calcd for $C_{12}H_{37}N_{11}P_4$: C, 31.4; H, 8.1; N, 33.5. Found: C, 31.1; H, 8.0; N, 32.8. Further crops of crystals were obtained from the mother liquor (240 h) which were identified as 2,4,4,6,8,8-hexakis(dimethylamino)bis(methylamino)cyclotetraphosphazetetraene, $N_4P_4(NMe_2)_6(NHMe)_2$, mp 41-43 °C (2.3 g, 46%). Anal. Calcd for $C_{14}H_{44}N_{12}P_4$: C, 32.6; H, 8.7; N, 32.6. Found: C, 33.6; H, 8.8; N, 33.2.

Reactions of $N_4P_4Cl_6(NHR)_2$ with an Excess of Dimethylamine in Chloroform or Methyl Cyanide. These reactions were carried out by utilizing the procedure indicated above. In general, the reactions gave a mixture of products.⁸ In most cases, a hydrochloride adduct of the fully aminolyzed cyclotetraphosphazene, $N_4P_4(NMe_2)_6(NHR)_2 \cdot xHCl$ (Table I), could be isolated by fractional crystallization from $CHCl_3$

Table I. Yields of Products Formed in the Reaction of $N_4P_4Cl_6(NHR)_2$ with Dimethylamine in $CHCl_3$ (ca. 58 °C) and CH_3CN (ca. 80 °C)^a

R	% $N_4P_4(NMe_2)_6(NHR)_2$ ^b		% $N_4P_4(NMe_2)_6(NHR)_2 \cdot xHCl$ ^b		% $N_4P_4(NMe_2)_5(NHR)NR$	
	$CHCl_3$	CH_3CN	$CHCl_3$	CH_3CN	$CHCl_3$	CH_3CN
Me	46 ^c				30 ^c	
Et	33 ^{c,d}	30	3 ^{c,d}	35 ^c	52 ^{c,d}	14
<i>n</i> -Pr	36	10 ^e		68 ^c	54	10 ^e
<i>i</i> -Pr	20	20 ^c	52 ^c	66 ^c	0	0
<i>n</i> -Bu	65	9		64 ^c	22	8
<i>t</i> -Bu	13	46 ^{c,f}	65 ^c	27 ^{c,f}	0	0
CH_2Ph	40	70 ^e			40	10 ^e
Ph	66				0	
Et, <i>t</i> -Bu	31				45	

^a On the basis of $N_4P_4Cl_6(NHR)_2$; estimated by ^{31}P NMR ($\pm 2\%$).
^b These derivatives have been characterized by elemental analyses, 1H and ^{31}P NMR spectroscopic data.⁷ For the hydrochloride adducts, $x = 2$, when $R = NHEt$; $x = 1$ in other cases.⁷ ^c Yields of product isolated. ^d Data from ref 4. ^e Approximate value ($\pm 5\%$) estimated visually from TLC. ^f Data from ref 6.

or CH_2Cl_2 . Attempts to separate the components of the residual reaction mixtures were unsuccessful.⁹ The mixtures were treated with triethylamine in boiling benzene to convert any remaining hydrochloride adduct to its free base, $N_4P_4(NMe_2)_6(NHR)_2$. The yields of the latter and of the "bicyclic" phosphazene $N_4P_4(NMe_2)_5(NHR)(NR)$ present in the reaction mixture were conveniently estimated by ^{31}P NMR spectroscopy and are shown in Table I. Signals at low field (ca. δ 17.0-22.0) are assigned to the "bicyclic" phosphazenes; those at high field (ca. δ 6.0-10.0) are assigned to the fully aminolyzed cyclotetraphosphazenes (see Discussion). The ^{31}P { 1H } NMR spectrum of a typical mixture¹⁰ is shown in Figure 2.

The reactions of $N_4P_4Cl_6(NHEt)_2$ (I) with an excess of dimethylamine in diethyl ether, methylene chloride, and carbon tetrachloride were also carried out (Table II). This table includes the result of an analogous reaction in chloroform with a stoichiometric amount of dimethylamine (5-6 mol/mol of I) and a twofold excess of triethylamine as hydrogen chloride acceptor.

The 1H NMR spectra ($CDCl_3$ solution, Me_4Si internal standard) were recorded with Jeol MH 100 and Varian HR 100 and HR 220 spectrometers. The ^{31}P { 1H } NMR spectra were obtained with a Bruker WH 90 spectrometer by using $CDCl_3$ solutions and 85% phosphoric acid as external standard. Chemical shifts are expressed on the δ scale with upfield shifts negative. The IR spectra were obtained in Nujol mulls by using a Perkin-Elmer 457 spectrometer.

Results and Discussion

We have previously isolated and characterized the "bicyclic" phosphazene $N_4P_4(NMe_2)_5(NHEt)(NEt)$ (IV)⁴ and X-ray

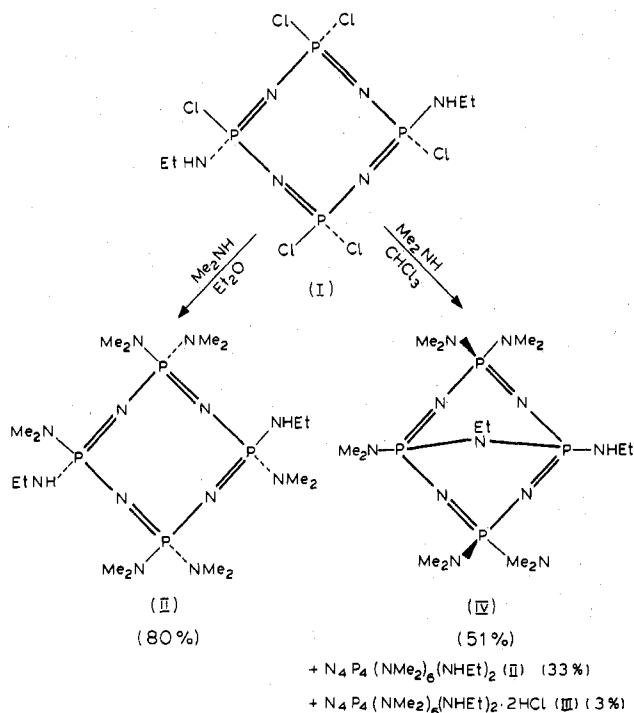

Figure 1. Reactions of $N_4P_4Cl_6(NHET)_2$ (I) with dimethylamine in Et_2O and $CHCl_3$ (yields in parentheses).

Table II. Yields of $N_4P_4(NMe_2)_5(NHET)(NEt)$ (IV) and $N_4P_4(NMe_2)_6(NHET)_2$ (II) in the Reaction of $N_4P_4Cl_6(NHET)_2$ (I) with Dimethylamine in Different Solvents

solvent	yield, ^a %	
	$N_4P_4(NMe_2)_5(NHET)(NEt)$ (IV)	$N_4P_4(NMe_2)_6(NHET)_2$ (II)
$CHCl_3$ ^b	45	49
$CHCl_3$ ^{c,d}	52	33
$CHCl_3/Et_3N$ ^b	74	18
CH_2Cl_2 ^b	38	55
CH_3CN ^c	13	65 ^e
CCl_4 ^c		76 ^f
Et_2O ^b		80 ^f

^a On the basis of starting material (I); estimated from ^{31}P NMR.

^b Reaction carried out at ca. 25 °C. ^c Reaction carried out in boiling solvent. ^d Data from ref 4. ^e Includes 35% of $N_4P_4(NMe_2)_6(NHET)_2 \cdot 2HCl$ (III). ^f Yield of pure product isolated.

crystallography confirms the proposed structure.¹¹ The proton and ^{31}P NMR spectra of compound IV have several unusual features which are relevant to an understanding of the NMR spectra of the new bicyclic phosphazenes reported here. The 1H NMR spectrum of compound IV reveals three distinct NMe_2 environments. The methyl protons of the NMe_2 group attached to the junction phosphorus atom P(2) are considerably deshielded compared to those of the NMe_2 groups attached to P(4) and P(8). The two NMe_2 groups at both P(4) and P(8) are nonequivalent. The protons of the NMe_2 group directed toward the bridgehead nitrogen atom N(9) resonate at higher field.⁴ The NCH_2CH_3 protons at the junction phosphorus atom P(6) are deshielded compared to those at the bridgehead nitrogen N(9). Two NCH_2CH_3 triplets are also observed (see Figure 3 for data and numbering of atoms). The phosphorus chemical shifts for this "bicyclic" phosphazene (IV) (δ 22.5, 19.7, 18.9)⁴ are very different from those of the related monocyclic derivative $N_4P_4(NMe_2)_6(NHET)_2$ (II) (δ 9.2, 6.8).⁵

The 220-MHz 1H NMR spectrum of the derivative $N_4P_4(NMe_2)_5(NHMe)(NMe)$ (V) is shown in Figure 4 and

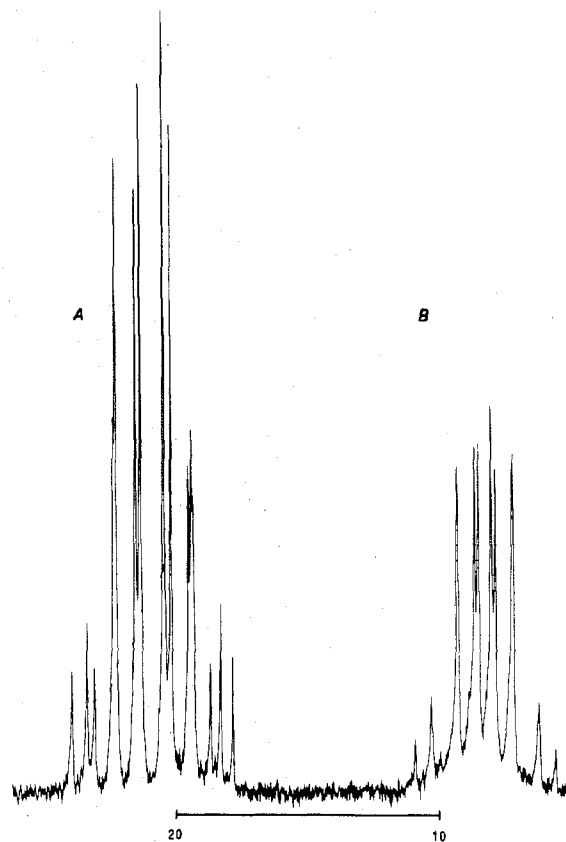

Figure 2. The $^{31}P\{^1H\}$ FT NMR spectrum (36.43 MHz) of a mixture of (A) $N_4P_4(NMe_2)_5(NH-n-Pr)(N-n-Pr)$ (VI) and (B) $N_4P_4(NMe_2)_6(NH-n-Pr)_2$.

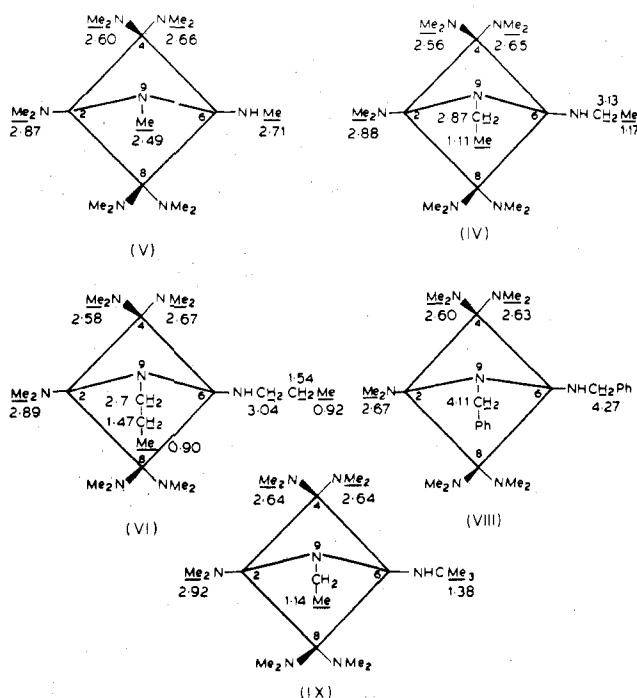

Figure 3. 1H NMR assignments (δ) for "bicyclic" phosphazenes; $^3J^*(P-H)$ values (NCH_2 , 9.0–11.0 Hz; NCH_3 , 10.0–11.5 Hz) are unexceptional. The corners of the square represent the phosphorus atoms; ring nitrogen atoms are not shown; substituents pointing toward the bridgehead, N(9), are denoted by shaded lines.

is best interpreted on the basis of a "bicyclic" structure. Four doublets are observed at δ 2.87, 2.71, 2.66, and 2.60 with relative intensities 2:1:4:4; a triplet at δ 2.49 (relative intensity 1) is also observed. The assignments of these resonances follow

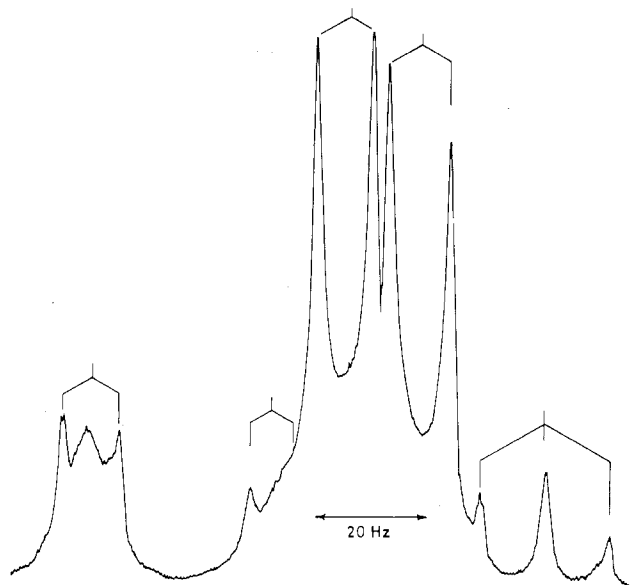
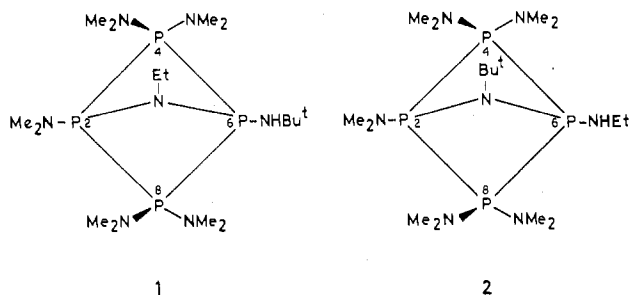

Figure 4. The ^1H NMR spectrum (220 MHz) of $\text{N}_4\text{P}_4(\text{NMe}_2)_5(\text{NHMe})(\text{NMe})$ (V) in $\text{CDCl}_3/\text{D}_2\text{O}$.

from the guidelines summarized above and are shown in Figure 3. The ^{31}P $\{^1\text{H}\}$ NMR spectrum is a complex, asymmetric multiplet centered at δ 21.4 and is clearly characteristic of a "bicyclic" phosphazene.^{1,4} The 220-MHz proton spectrum of the propylamino "bicyclic" derivative (VI) can also be readily analyzed. Its ^{31}P $\{^1\text{H}\}$ NMR spectrum approximates to an A_2B_2 pattern (Figure 2A) owing to the accidental coincidence of the chemical shifts of P(2) and P(6) [$\delta_{\text{P}(4),(8)} = 22.4$, $\delta_{\text{P}(2)} \approx \delta_{\text{P}(6)} = 19.5$, $^2J(\text{P}-\text{P}) = 43.0$ Hz].

The formation of the "bicyclic" phosphazenes $\text{N}_4\text{P}_4(\text{NMe}_2)_5(\text{NHR})(\text{NR})$ [$\text{R} = n\text{-Bu}$ (VII) and CH_2Ph (VIII)] is conclusively established by ^{31}P NMR spectroscopy. The spectrum of the *n*-butyl compound (VII) is very similar to that of the *n*-propyl analogue (VI) in both its position and appearance. The spectrum of the benzyl compound (VIII) is an asymmetric A_2BC pattern (δ 24–15). It has not been possible to separate these "bicyclic" phosphazenes from their respective monocyclic compounds, $\text{N}_4\text{P}_4(\text{NMe}_2)_6(\text{NHR})_2$. The ^1H NMR assignments shown (Figure 3) for the benzyl derivative (VIII) have been made by comparing the spectrum of the mixture with that of the pure cyclotetraphosphazene derivative.¹²

The bicyclic phosphazene (IX) formed in the reaction of $\text{N}_4\text{P}_4\text{Cl}_6(\text{NH-}t\text{-Bu})(\text{NHEt})$ with an excess of dimethylamine in chloroform can have two possible structures (1 and 2). The



^{31}P $\{^1\text{H}\}$ NMR spectrum of this bicyclic compound is of an A_2BC type consisting of two groups of lines at δ 21.6–19.2 and δ 17.4–14.3 (relative intensities 3:1). As the ^{31}P shifts of a $\equiv\text{P}(\text{NH-}t\text{-Bu})$ group in cyclotri- and cyclotetraphosphazenes occur upfield to the shifts of phosphorus nuclei bearing other alkylamino substituents,^{6,7,13} it is reasonable to assign the signals at δ 17.4–14.3 to the $\equiv\text{P}(6)\text{NH-}t\text{-Bu}$ group¹⁴ (structure 1). This structure is also supported by ^1H NMR data. The $-\text{C}(\text{CH}_3)_3$ signal occurs at δ 1.38 (Figure 3) which is downfield

Table III. Selected IR Data for Bicyclic Phosphazenes^a

Compound	$\nu(\text{P}=\text{N})$ ring, cm^{-1}	P(2)-N-P(6) vibrations, cm^{-1}
$\text{N}_4\text{P}_4(\text{NMe}_2)_5(\text{NHMe})(\text{NMe})$ (V)	1190 vs	790 m, 828 s, 840 s, sh
$\text{N}_4\text{P}_4(\text{NMe}_2)_5(\text{NHEt})(\text{NEt})$ (IV)	1195 vs	790 m, 830 s, 838 s, sh
$\text{N}_4\text{P}_4(\text{NMe}_2)_5(\text{NH-}n\text{-Pr})(\text{N-}n\text{-Pr})$ (VI)	1190 vs	795 m, 822 s, 838 m, sh
$\text{N}_4\text{P}_4(\text{NMe}_2)_5(\text{NH-}n\text{-Bu})(\text{N-}n\text{-Bu})$ (VII)	1190 vs	800 m, 830 s
$\text{N}_4\text{P}_4(\text{NMe}_2)_5(\text{NHCH}_2\text{Ph})$ - (NCH_2Ph) (VIII)	1195 vs	800 m, 830 s
$\text{N}_4\text{P}_4(\text{NMe}_2)_5(\text{NH-}t\text{-Bu})(\text{NEt})$ (IX)	1185 vs	795 m, 825 m, 840 m

^a vs = very strong, s = strong, m = medium, sh = shoulder.

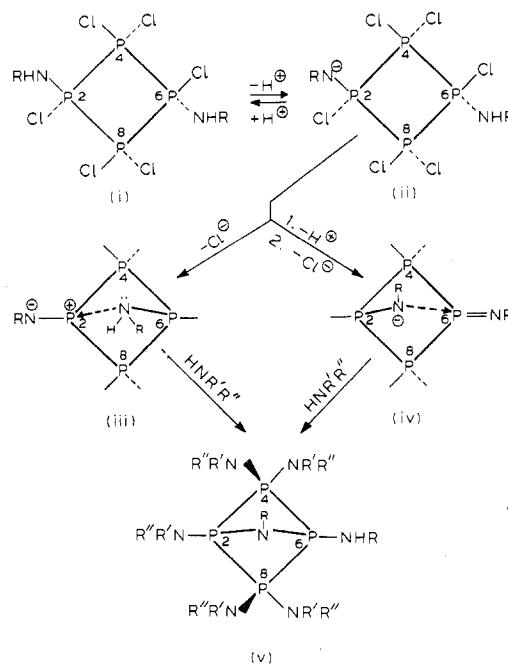

Figure 5. Possible mechanisms for the formation of "bicyclic" phosphazenes. For simplicity, the exocyclic groups in structures (iii) and (iv) are not shown; the stage of chlorine replacement at which the bridge formation occurs has not been determined (see text).

to that observed (δ 1.23) for the corresponding cyclotetraphosphazene derivative $\text{N}_4\text{P}_4(\text{NMe}_2)_6(\text{NH-}t\text{-Bu})(\text{NHEt})$.⁷

The infrared spectra of fully aminolyzed cyclotetraphosphazenes, $\text{N}_4\text{P}_4(\text{NRR}')_8$, show a strong vibration, $\nu(\text{P}=\text{N})$, at $1250\text{--}1270\text{ cm}^{-1}$.^{7,15} In the IR spectra of "bicyclic" phosphazenes, $\text{N}_4\text{P}_4(\text{NMe}_2)_5(\text{NHR})(\text{NR})$, a strong band occurs at ca. 1190 cm^{-1} which may be assigned to $\nu(\text{P}=\text{N})$. The spectra of "bicyclic" phosphazenes also contain strong bands at $790\text{--}840\text{ cm}^{-1}$ which are absent in the spectra of the corresponding aminocyclotetraphosphazenes. The vibrations in the 800-cm^{-1} region (Table III) are clearly associated with the P(2)-N-P(6) bridging unit.¹ The above features permit a ready distinction between "bicyclic" phosphazenes and the cyclotetraphosphazenes, $\text{N}_4\text{P}_4(\text{NMe}_2)_6(\text{NHR})_2$.

Formation of "bicyclic" phosphazenes takes place when cyclotetraphosphazenes bearing primary amino substituents at the 2,6-positions react with a strong nucleophile (Me_2NH , MeNH_2 , EtNH_2). The "bicyclic" phosphazene must be formed in an intramolecular trans-annular nucleophilic substitution which probably involves a proton abstraction step (Figure 5). Two limiting cases may be envisaged: (a) reversible proton abstraction at P(2) followed by addition of P(6)NHR across P(2)=N [Figure 5(iii)] and (b) a double proton abstraction at P(2) and P(6) followed by intramolecular

attack [Figure 5(iv)]. The observation that addition of a strong base (triethylamine) considerably enhances the yield of $N_4P_4(NMe_2)_5(NHEt)(NEt)$ (IV) provides supporting evidence for a proton abstraction mechanism.¹⁶ Goldschmidt and Gabay have observed that the yield of geminal $N_3P_3Cl_4(NHMe)_2$ relative to that of the nongeminal isomers increases as the concentration of triethylamine in the reaction mixture increases.¹⁷ It is generally accepted that a proton abstraction mechanism is involved in the formation of geminal derivatives during the reactions of $N_3P_3Cl_6$ with primary amines.^{15,18} This type of mechanism is rendered plausible by the isolation and characterization of three-coordinate phosphorus(V) compounds.¹⁹ A proton abstraction mechanism is also probably involved in other cyclization reactions of linear P(III) and P(V) species containing primary amino substituents to give phosphorus-nitrogen ring compounds.²⁰

A "bicyclic" compound is not obtained from either the reaction of the monoderivative $N_4P_4Cl_7(NHEt)$ with dimethylamine in chloroform²³ (even in the presence of Et_3N) or the reaction of 2-*trans*-6- $N_4P_4Cl_2(NMe_2)_6$ with ethylamine in chloroform.²⁴ These observations suggest that a mechanism involving a direct attack by P(2)-NHR [or P(2)⁺-NR⁻] on P(6) with expulsion of Cl^- is unlikely and that proton abstraction at both phosphorus sites may be significant. The electrophilicity of the phosphazene substrate also appears to be important. The 2,6-bis(ethylamino) derivative (I) does not give any "bicyclic" product when heated with triethylamine in boiling chloroform and is recovered unchanged (³¹P NMR evidence). Therefore, it seems probable that the *trans*-annular attack only takes place after (or with synchronous) replacement of some of the residual chlorine atoms by dimethylamine. Further studies are needed to establish the stage of chlorine replacement at which the P-N(R)-P bridge is formed.

The formation of "bicyclic" phosphazenes is markedly influenced by the reaction solvent. In carbon tetrachloride or diethyl ether, only the cyclotetraphosphazene derivative, $N_4P_4(NMe_2)_6(NHEt)_2$ (II), has been isolated. Among the other solvents investigated, the yield of the bicyclic product increases in the order $CH_3CN \ll CH_2Cl_2 < CHCl_3$. The acidic character of the protons of these solvents increases in the same order. These acidic protons may facilitate the solvation of the $\equiv PCl(NHR)$ group and thus promote the heterolysis of the P-Cl bond. In addition, these solvents may stabilize the species formed after proton abstraction by hydrogen bonding to the electron-rich nitrogen atom involved in the intramolecular attack. Diethyl ether, a donor solvent, and carbon tetrachloride, a nonpolar solvent, probably do not favor the formation of such species.

The formation of "bicyclic" phosphazenes is also influenced by both electronic and steric factors associated with the primary amino substituents in the cyclotetraphosphazene substrate. The yield of $N_4P_4(NMe_2)_5(NHR)(NR)$ increases in the order $R = Me < CH_2Ph < Et < n-Pr$.²⁵ The yield of the "bicyclic" phosphazene VII ($R = n-Bu$) is very low and there is no evidence that such compounds form when $R = i-Pr$, *t*-Bu, or Ph (Table I). Branching at the α -carbon atom clearly inhibits the formation of the "bicyclic" system, and the steric effect of a longer alkyl chain decreases the yield substantially. The "bicyclic" phosphazene $N_4P_4(NMe_2)_5(NH-t-Bu)(NEt)$ (IX) contains an ethyl group (and not a *tert*-butyl group) attached to the bridgehead nitrogen N(9) which again demonstrates a steric effect. The absence of the phenyl "bicyclic" compound may be attributed largely to an electronic effect, although α branching could also be a contributory factor.

In conclusion, three major types of reaction occur in the aminolysis reactions of the octachloride, $N_4P_4Cl_8$, and its bis(alkylamino) derivatives, $N_4P_4Cl_6(NHR)_2$: (a) "normal" stepwise replacement of chlorine atoms to give partially and fully substituted cyclotetraphosphazene derivatives,^{5,6,26,27} (b) an intramolecular nucleophilic reaction leading to the formation of "bicyclic" phosphazenes, and (c) intermolecular condensation processes resulting in the formation of resins.⁴⁻⁶ The competition between these three reactions depends on the reaction medium, the nucleophile, and the substituent present on the phosphazene substrate.

Acknowledgment. We are greatly indebted to the University Grants Commission, New Delhi, and to the overseas Development Ministry, London, for support. We thank the Science Research Council, U. K., for a P.C.M.U. allowance (to R.A.S. for 220-MHz NMR) and Mrs. E. Summers, Kings College, London (ULIRS), for assistance with ³¹P NMR measurements.

Registry No. I, 60998-10-9; II, 60998-15-4; III, 62763-53-5; IV, 58752-23-1; V, 70197-78-3; VI, 70197-79-4; VII, 70197-80-7; VIII, 70197-81-8; IX, 70197-82-9; $N_4P_4Cl_6(NHMe)_2$, 70197-83-0; $N_4P_4Cl_6(NH-n-Pr)_2$, 70197-84-1; $N_4P_4Cl_6(NH-i-Pr)_2$, 70197-85-2; $N_4P_4Cl_6(NH-n-Bu)_2$, 70197-86-3; $N_4P_4Cl_6(NH-t-Bu)_2$, 70197-87-4; $N_4P_4Cl_6(NHCH_2Ph)_2$, 70197-88-5; $N_4P_4Cl_6(NHPh)_2$, 70197-89-6; $N_4P_4Cl_6(NHEt)(NH-t-Bu)$, 70197-90-9; $N_4P_4(NMe_2)_6(NHMe)_2$, 70197-91-0; $N_4P_4(NMe_2)_6(NH-n-Pr)_2$, 70197-92-1; $N_4P_4(NMe_2)_6(NH-i-Pr)_2$, 70197-93-2; $N_4P_4(NMe_2)_6(NH-n-Bu)_2$, 70197-94-3; $N_4P_4(NMe_2)_6(NH-t-Bu)_2$, 70197-95-4; $N_4P_4(NMe_2)_6(NHCH_2Ph)_2$, 70197-96-5; $N_4P_4(NMe_2)_6(NHPh)_2$, 70197-97-6; $N_4P_4(NMe_2)_6(NHEt)(NH-t-Bu)$, 70197-98-7; $N_4P_4(NMe_2)_6(NH-n-Pr)_2 \cdot xHCl$, 70224-74-7; $N_4P_4(NMe_2)_6(NH-i-Pr)_2 \cdot xHCl$, 70224-73-6; $N_4P_4(NMe_2)_6(NH-n-Bu)_2 \cdot xHCl$, 70197-99-8; $N_4P_4(NMe_2)_6(NH-t-Bu)_2 \cdot xHCl$, 70198-00-4; dimethylamine, 124-40-3.

References and Notes

- (1) Part 8: S. S. Krishnamurthy, K. Ramachandran, and M. Woods, *J. Chem. Res. (S)*, 92 (1979); *J. Chem. Res. (M)*, 1258-1266 (1979).
- (2) Indian Institute of Science.
- (3) Birkbeck College (University of London).
- (4) S. S. Krishnamurthy, A. C. Sau, A. R. Vasudeva Murthy, R. Keat, R. A. Shaw, and M. Woods, *J. Chem. Res. (S)*, 70 (1977); *J. Chem. Res. (M)*, 860-884 (1977).
- (5) S. S. Krishnamurthy, A. C. Sau, A. R. Vasudeva Murthy, R. Keat, R. A. Shaw, and M. Woods, *J. Chem. Soc., Dalton Trans.*, 1405 (1976).
- (6) S. S. Krishnamurthy, A. C. Sau, A. R. Vasudeva Murthy, R. A. Shaw, M. Woods, and R. Keat, *J. Chem. Soc., Dalton Trans.*, 1980 (1977).
- (7) K. Ramachandran, Ph.D. Thesis, Indian Institute of Science, Bangalore, 1978.
- (8) $N_4P_4(NMe_2)_5(NHR)(NR)$, $N_4P_4(NMe_2)_6(NHR)_2$, and $N_4P_4(NMe_2)_6(NHR)_2 \cdot xHCl$. A bicyclic phosphazene hydrochloride, $N_4P_4(NHEt)_6(NEt) \cdot HCl$, has been characterized but no evidence was found for $N_4P_4(NMe_2)_5(NHR)(NR) \cdot HCl$.⁴ The workup procedure adopted in many of the experiments described in this paper obviously excludes the possibility of characterizing "bicyclic" phosphazene hydrochloride adducts but their formation cannot be discounted entirely.
- (9) A "bicyclic" phosphazene (lower R_f) and its related fully aminolyzed cyclotetraphosphazene can be distinguished by TLC (silica; ethyl acetate eluant). However, attempts to separate them by column chromatography (silica) failed. The *n*-propyl "bicyclic" phosphazene (VI), mp 116-118 °C, crystallized from the reaction mixture after many months.
- (10) Independent experiments indicate that the decoupling and FT techniques do not introduce significant errors in the relative integrated intensities.
- (11) T. S. Cameron and Kh. Mannan, *Acta Crystallogr., Sect. B*, **33**, 443 (1977).
- (12) The cyclotetraphosphazene derivatives, $N_4P_4(NMe_2)_6(NHR)_2$, are easily prepared⁷ by the reaction of $N_4P_4Cl_6(NHR)_2$ and dimethylamine in solvents such as Et_2O or CCl_4 (see also Tables I and II).
- (13) R. Keat, R. A. Shaw, and M. Woods, *J. Chem. Soc., Dalton Trans.*, 1582 (1976).
- (14) For structure **2**, the resonances of both P(2) and P(6) (linked by the >N-*t*-Bu group) would occur in a region upfield and well separated from those of P(4) and P(8) and would contribute half the total intensity of the entire A_2BC spectrum.
- (15) H. R. Allcock, "Phosphorus-Nitrogen Compounds", Academic Press, New York, 1972; S. S. Krishnamurthy, A. C. Sau, and M. Woods, *Adv. Inorg. Chem. Radiochem.*, **21**, 41 (1978).
- (16) The overall yield of "bicyclic" compound increases with increase in the base strength of the nucleophile ($Me_2NH > EtNH_2 > MeNH_2$) and this observation is consistent with the proposed proton abstraction mechanism. However, the total yield of crystalline products is depressed

- in the reactions with primary amines^{1,4} and substantial quantities of resins are formed. A proton abstraction mechanism has also been proposed for this resin-forming, side reaction.⁵
- (17) J. M. E. Goldschmidt and Z. Gabay, "2nd IUPAC Symposium on Inorganic Phosphorus Compounds", Prague, 1974, Abstract No. 3.12.
- (18) S. K. Das, R. Keat, R. A. Shaw, and B. C. Smith, *J. Chem. Soc.*, 5032 (1965); R. Das, R. A. Shaw, B. C. Smith, and M. Woods, *J. Chem. Soc., Dalton Trans.*, 709 (1973); D. J. Lingley, R. A. Shaw, M. Woods, and S. S. Krishnamurthy, *Phosphorus Sulfur*, 4, 379 (1978).
- (19) S. Pohl, E. Niecke, and B. Krebs, *Angew. Chem., Int. Ed. Engl.*, 14, 261 (1975); O. J. Scherer and N. Kuhn, *Chem. Ber.*, 107, 2123 (1974).
- (20) Many reactions of this type are known²¹ but their mechanisms have not been fully unraveled. However, it is interesting to note that Kukhar has observed facile cyclization of (RNH)P(O)(Cl)N(R)P(O)Cl₂ in the presence of triethylamine.²²
- (21) For example, see R. R. Holmes, *J. Am. Chem. Soc.*, 83, 1334 (1961); R. R. Holmes and J. A. Forstner, *Inorg. Chem.*, 2, 380 (1963); R. Jefferson, J. F. Nixon, T. M. Painter, R. Keat, and L. Stobbs *J. Chem. Soc., Dalton Trans.*, 1414 (1973); G. Bulloch and R. Keat, *ibid.*, 2010 (1974); J. D. Healy, R. A. Shaw, and M. Woods, *Phosphorus Sulfur*, 5, 239 (1978).
- (22) V. P. Kukhar, *J. Gen. Chem. USSR*, 40, 761 (1970).
- (23) N₄P₄(NMe₂)₂(NHEt), mp 92 °C, is obtained (73%).
- (24) N₄P₄(NHEt)₂(NMe₂)₆² is obtained (75%).
- (25) With the exception of R = CH₂Ph, this trend parallels the increase in electron-releasing power of the substituent.
- (26) D. Millington and D. B. Sowerby, *J. Chem. Soc., Dalton Trans.*, 2035 (1972).
- (27) S. S. Krishnamurthy, M. N. Sudheendra Rao, A. R. Vasudeva Murthy, R. A. Shaw, and M. Woods, *Inorg. Chem.*, 17, 1527 (1978).

Contribution from the Department of Chemistry,
Tel-Aviv University, Tel-Aviv, Israel

The Hexaamminecobalt Electron-Exchange Reaction

EPHRAIM BUHKS, MORDECHAI BIXON,* JOSHUA JORTNER,* and GIL NAVON*

Received September 22, 1978

In this paper we present a theoretical study of the extraordinarily slow electron-exchange reaction $\text{Co}^{3+}(\text{NH}_3)_6 + \text{Co}^{2+}(\text{NH}_3)_6 \xrightarrow{k_1} \text{Co}^{2+}(\text{NH}_3)_6 + \text{Co}^{3+}(\text{NH}_3)_6$. With the utilization of multiphonon theory for nonadiabatic electron-transfer reactions, k_1 was expressed as a product of a two-center electron-exchange term, $|V_{if}|^2$, and a nuclear Franck-Condon factor, G . $|V_{if}|^2$ was evaluated by invoking the effects of spin-orbit coupling, while G was calculated by incorporating the effects of configurational changes and of frequency changes in the first coordination layer, as well as the Marcus-Levich solvent reorganization energy. We demonstrate that both electronic spin multiplicity restrictions and the nuclear reorganization energy contribute significantly to the retardation of the rate of this reaction. The mechanism considered herein is more efficient than the alternative reaction paths which involve thermally excited electronic states.

I. Introduction

There have been extensive experimental¹⁻³ and theoretical^{4,5} studies of electron-transfer reactions between coordination complexes in solution. An unsolved problem in this area pertains to the enormous difference between the rates of the symmetric electron-exchange reactions⁶⁻⁸ (1) and (2), where

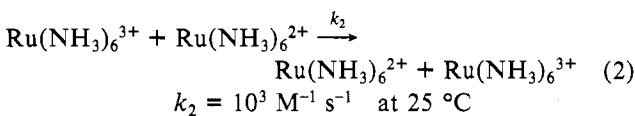
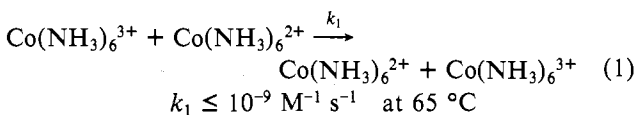

at room temperature (25 °C) $k_1/k_2 \approx 10^{-13}$ – 10^{-15} . The extraordinarily slow rate of some electron-exchange reactions has been attributed by Libby⁹ about 25 years ago to small Franck-Condon vibrational overlap, originating from large configurational changes in the first coordination layer.⁶ However, recent classical calculations of this activation barrier¹⁰ result in a contribution of 6.8 kcal mol⁻¹ to the activation energy, which is too low to account for the small value of k_1 . Alternatively, spin multiplicity restrictions have been introduced to account for the slow exchange rate k_1 .¹⁰ These two effects are interrelated. As was pointed out by Orgel,¹¹ high spin-low spin exchange results in large configurational changes in the first coordination layer.

In this paper we report a quantum mechanical calculation of the relative exchange rate k_1/k_2 . We show that both the electronic spin multiplicity restriction and the Franck-Condon reorganization energy contribute significantly to the retardation of the electron exchange reaction (eq 1). Both effects should be incorporated in a quantitative theory of electron transfer in this system. We shall utilize a quantum mechanical rate equation developed for nonadiabatic outer-sphere elec-

tron-exchange reaction. It incorporates the following contributions: (1) the electronic-exchange matrix element, (2) the Marcus-Levich reorganization energy of the classical polar solvent outside the first coordination layer, (3) the Franck-Condon overlap factors originating from configurational changes in the first coordination layer.

The transition probability, W , for the reaction

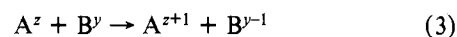

can be expressed in the form^{5,12}

$$W = \frac{2\pi}{\hbar} |V_{if}|^2 G(\Delta E, E_s, \{\Delta d_x\}, \{\omega_x'\}, \{\omega_x''\}) \quad (4)$$

The factor V_{if} is the two-center electron-exchange term between the two ions

$$V_{if} = \langle \Psi_f | V | \Psi_i \rangle \quad (5)$$

with Ψ_i and Ψ_f corresponding to the electronic wave functions of the initial state ($A^z + B^y$) and in the final state ($A^{z+1} + B^{y-1}$), respectively. The interaction V may be approximated as a sum of one-electron Coulomb interactions between the two ions. The function $G(\Delta E, E_s, \{\Delta d_x\}, \{\omega_x'\}, \{\omega_x''\})$ appearing in eq 4 is the equilibrium-averaged Franck-Condon factor, which takes into account the solvent and the vibrations of the first coordination layer. It is characterized by the set of its arguments: ΔE is the energy gap between the initial and final electronic states, E_s is the Marcus-Levich solvent reorganization energy, $\{\Delta d_x\}$ is the set of reduced displacements in the first coordination layer, $\{\omega_x'\}$ and $\{\omega_x''\}$ are the sets of vibrational frequencies in the initial and final states. All the electronic and nuclear terms appearing in eq 4 are evaluated at a fixed interionic separation.

In the next section we discuss and evaluate the electronic-exchange matrix element. Section III is devoted to the evaluation of the factor G and the overall rate constant. The results are presented in section IV, and alternative schemes